

# SHOWBIRD 65 MODULAR LIGHTBOX 10 X 10 CONFIGURATION B

SHOWBIRD 65 MODULAR LIGHTBOX

PRODUCT CODE: SB65-1010-B



## PRODUCT DESCRIPTION

The Showbird 65 Modular Lightbox Display is a sleek, versatile display solution engineered for impactful presentations and modular flexibility. Featuring a 65mm wide aluminum extrusion frame, this lightbox display offers premium quality and exceptional adaptability for trade shows, events, and retail environments.

### Brilliant Backlit Visuals

The Showbird 65 delivers vivid, high-resolution messaging with dye sublimated fabric graphics finished with SEG (silicone edge graphic) technology. The front-facing graphic is backlit by internal LED ladder lights mounted on a blackout SEG panel, ensuring vibrant illumination and visual impact. The backside features two SEG channels—an inner channel for the light panel and an outer channel for an optional non-backlit graphic, allowing for single or double-sided presentations.

### Tool-Free, Modular Design

Assembling the display is quick and easy thanks to its tool-free frame system. Designed with flexibility in mind, Showbird 65 frames are modular, allowing them to be used individually or in seamless multi-frame configurations. Choose from a range of standard configurations available online, or create your own with custom solutions tailored to your branding needs.

### Customizable & Expandable

Further enhance your display with optional accessories such as shelving units and monitor mounts, ideal for adding interactive or product-focused elements to your exhibit.

### Portable & Protected

Each frame includes an Oxford travel bag with EPP foam inserts, ensuring your hardware is protected during transport and storage.

DISPLAY DIMENSIONS	118.11"W x 96"H x 39.4 "D
--------------------	---------------------------

## GRAPHIC MATERIAL

FRONT GRAPHIC	Dye Sub Backlit Fabric
BACK GRAPHIC (OPTIONAL)	Dye Sub Stretch Fabric

## GRAPHIC FINISHING

12mm x 3mm silicone beading is sewn around the perimeter of the fabric graphic (Silicone Edge Graphic - SEG). Silicone beading is hidden from view once installed. A pull tab is added to a bottom corner to help with graphic removal.

## DISPLAY CONSTRUCTION

Aluminum frame with plastic components. LED ladder lights are attached to reflective fabric panel with SEG finishing. Transformer is mounted to bottom rail of frame.

OUTLETS REQUIRED	3 (1 per frame)
------------------	-----------------

## SHIPPING WEIGHTS & DIMENSIONS

### SB65-100X100 - 2 FRAMES (1 BOX EACH)

Shipping Weight (Each Frame)	15 lbs Single Graphic Package 16 lbs Double Graphic Package 14 lbs Hardware Only 1 lbs Graphic Only
Shipping Dimensions (Each Frame)	44"L x 11"W x 5"H - Graphic Package 44"L x 11"W x 5"H - Hardware Only Polybag - Graphic Only

### SB65-300X240 - 1 FRAME (1 BOX)

Shipping Weight	58 lbs Single Graphic Package 63 lbs Double Graphic Package 53 lbs Hardware Only 5 lbs Graphic Only
Shipping Dimensions	48"L x 20"W x 8"H - Graphic Package 48"L x 20"W x 8"H - Hardware Only Polybag - Graphic Only

## ADDITIONAL IMAGES



BACKSIDE - SINGLE SIDED



BACKSIDE - DOUBLE SIDED



SINGLE SIDED

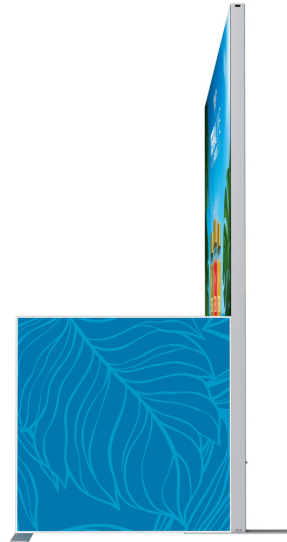

DOUBLE SIDED



TRAVEL BAG - SB65-300X240  
QTY 1



TRAVEL BAG - SB65-100X100  
QTY 2

# SHOWBIRD 65 MODULAR LIGHTBOX 10 X 10 CONFIGURATION B

SHOWBIRD 65 MODULAR LIGHTBOX  
PRODUCT CODE: SB65-1010-B

SINGLE  
SIDED

DOUBLE  
SIDED

INDOOR  
USE

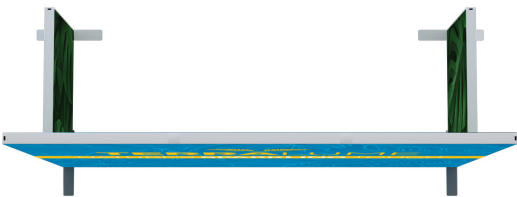

## HARDWARE ONLY PARTS LIST



(qty 1) Showbird 65 Modular  
Lightbox 300x240 Hardware Only  
SKU: SB65-300x240



(qty 2) Showbird 65 Modular  
Lightbox 100x100 Hardware Only  
SKU: SB65-100x100

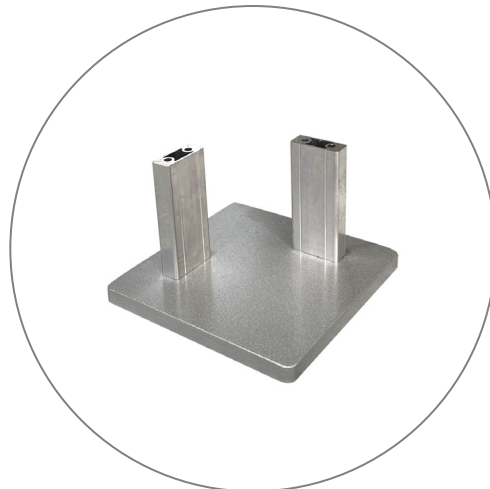

(qty 2) Corner Connector Foot  
SKU: SB65-FOOT-90

## SET UP INSTRUCTIONS - SB65-100X100

SET UP EACH FRAME INDIVIDUALLY BEFORE CONNECTING

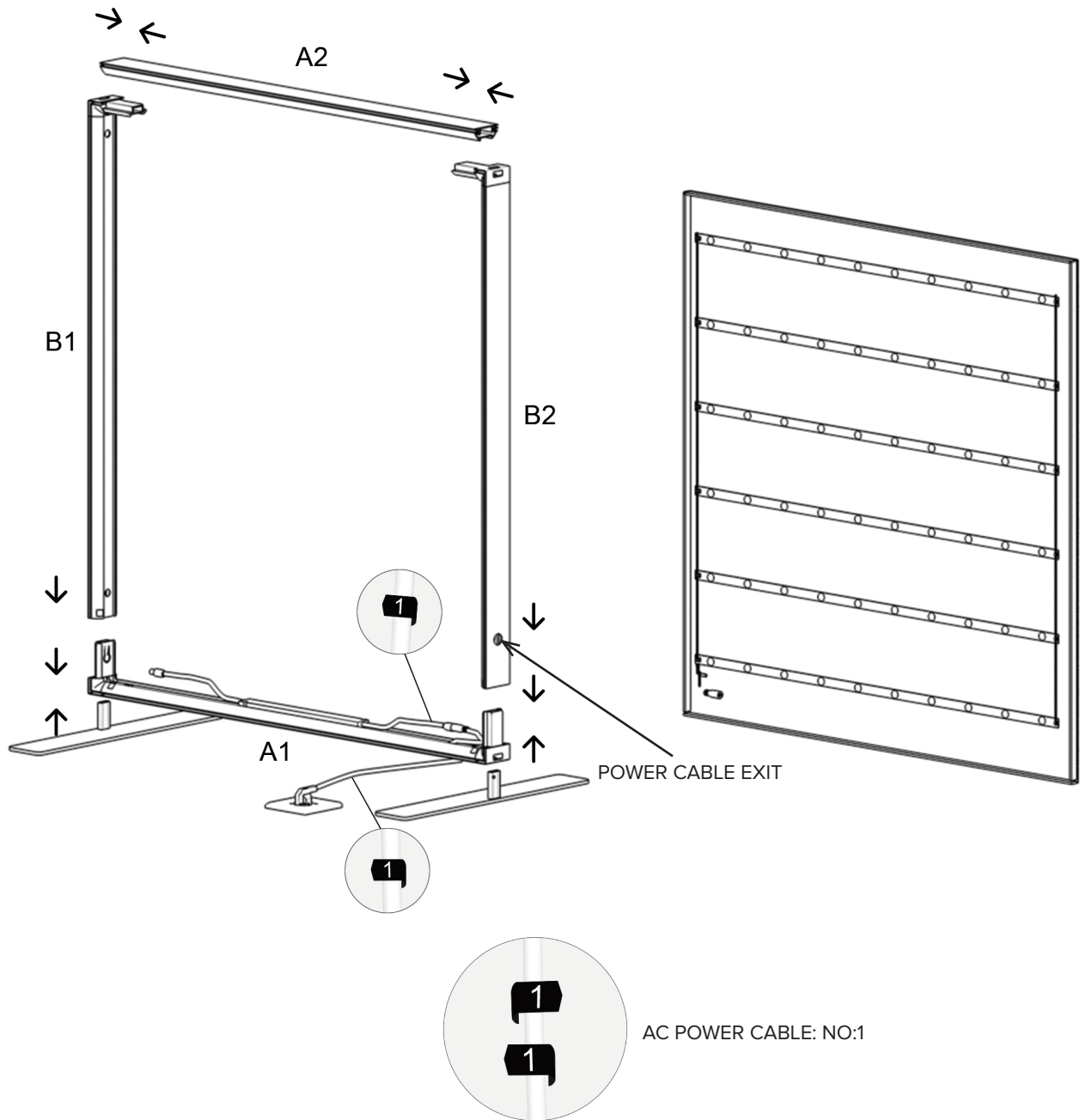

### LED PANEL

LED PANEL INSTALLS INTO THE INNER CHANNEL ON THE BACKSIDE OF THE LIGHTBOX FRAME. PANEL IS MARKED TOP/BOTTOM FOR EASY INSTALLATION. START BY INSERTING THE SILICONE INTO ALL 4 CORNERS OF THE FRAME AND THEN WORK YOUR WAY ACROSS EACH SIDE THE FRAME. DO NOT START IN 1 CORNER AND WORK YOUR WAY AROUND THE FRAME.

### OPTIONAL BACK PANEL\*

\*OPTIONAL BACK PANEL INSTALLS INTO THE OUTER CHANNEL ON THE BACKSIDE OF THE LIGHTBOX FRAME. FOLLOW THE SAME INSTALLATION STEPS AS THE LED PANEL

## SET UP INSTRUCTIONS - SB65-300X240

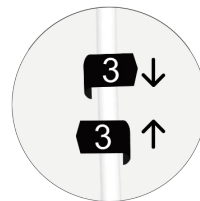
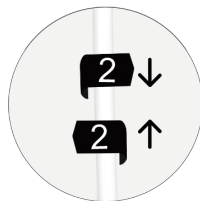
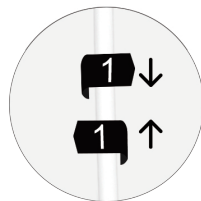
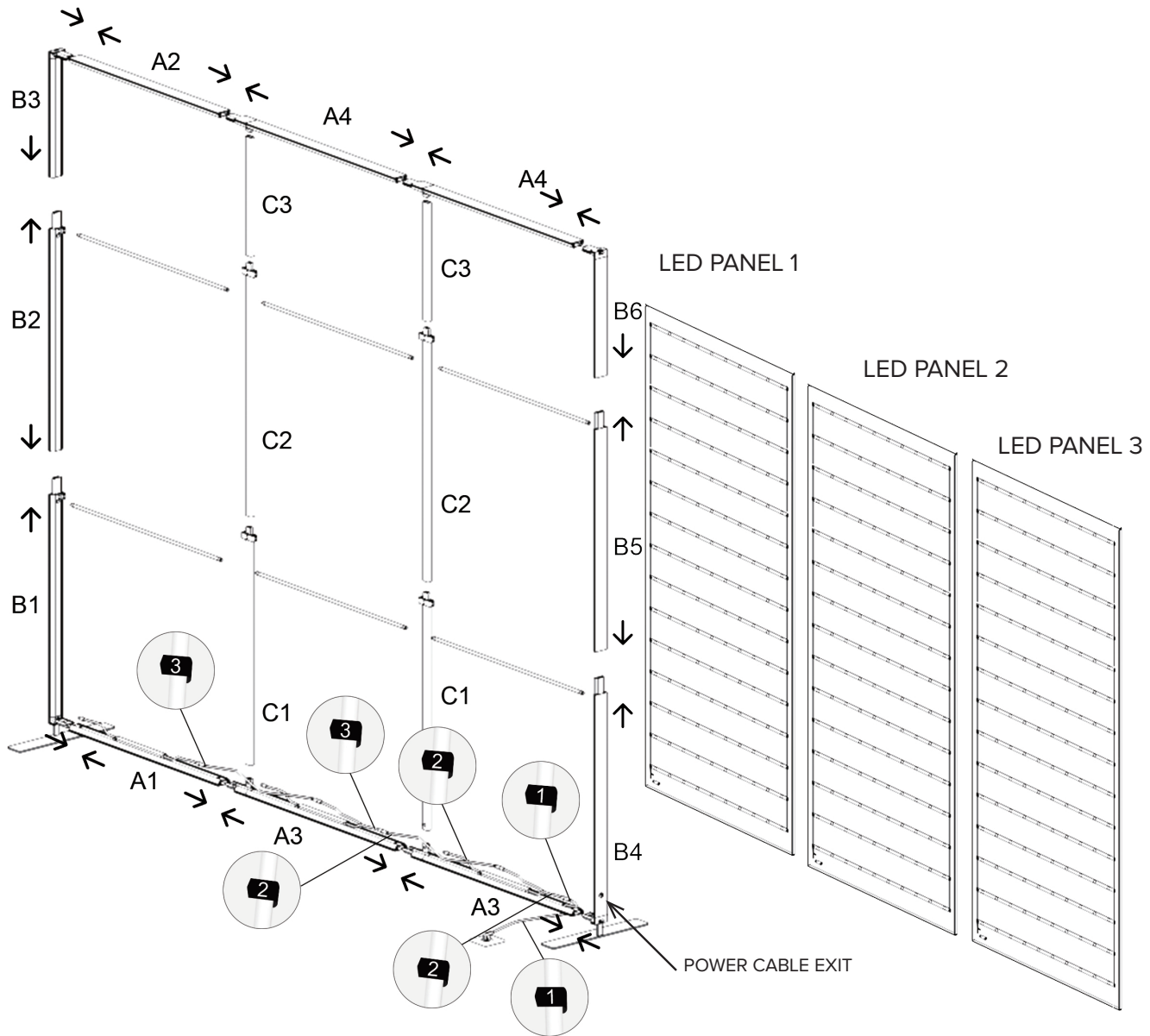

AC POWER CABLE: NO:1    EXTENSION CABLE: NO:2    EXTENSION CABLE: NO:3

### LED PANEL

LED PANEL INSTALLS INTO THE INNER CHANNEL ON THE BACKSIDE OF THE LIGHTBOX FRAME. PANEL IS MARKED TOP/BOTTOM FOR EASY INSTALLATION. START BY INSERTING THE SILICONE INTO ALL 4 CORNERS OF THE FRAME AND THEN WORK YOUR WAY ACROSS EACH SIDE THE FRAME. DO NOT START IN 1 CORNER AND WORK YOUR WAY AROUND THE FRAME.

### OPTIONAL BACK PANEL\*

\*OPTIONAL BACK PANEL INSTALLS INTO THE OUTER CHANNEL ON THE BACKSIDE OF THE LIGHTBOX FRAME. FOLLOW THE SAME INSTALLATION STEPS AS THE LED PANEL

# SHOWBIRD 65 MODULAR LIGHTBOX 10 X 10 CONFIGURATION B

SHOWBIRD 65 MODULAR LIGHTBOX  
PRODUCT CODE: SB65-1010-B

SINGLE  
SIDED

DOUBLE  
SIDED

INDOOR  
USE



## FRAME CONNECTION

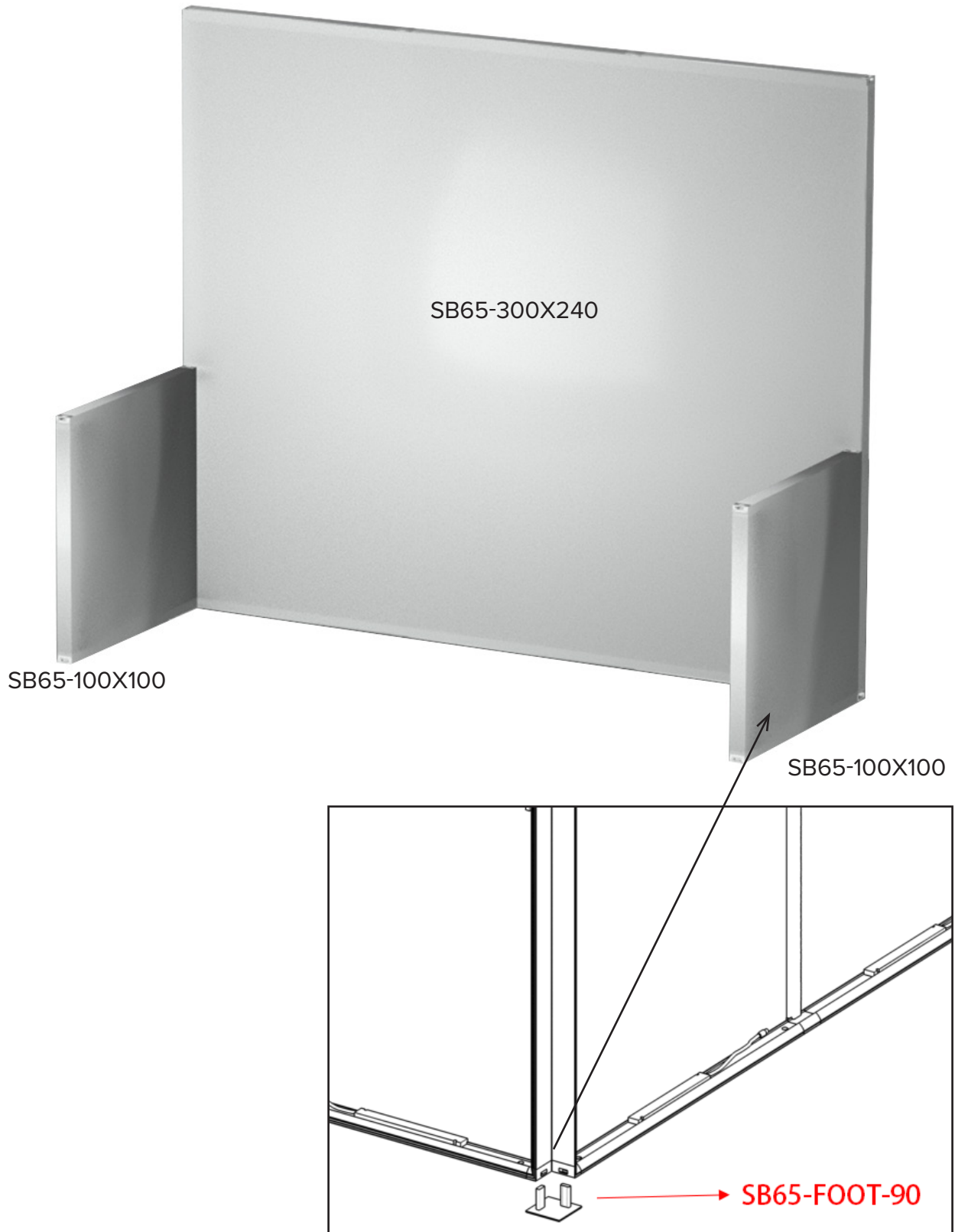

# SHOWBIRD 65 MODULAR LIGHTBOX 10 X 10 CONFIGURATION B

SHOWBIRD 65 MODULAR LIGHTBOX  
PRODUCT CODE: SB65-1010-B



## TRAVEL BAG STORAGE SB65-100X100

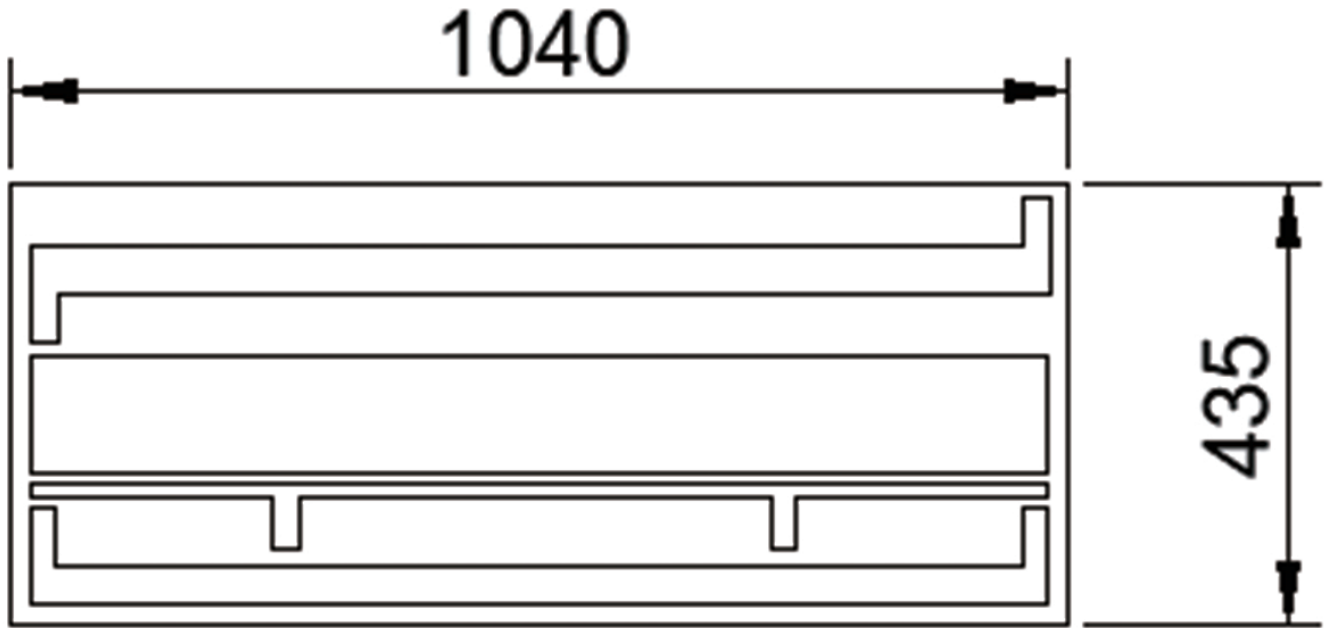



## TRAVEL BAG STORAGE SB65-300X240

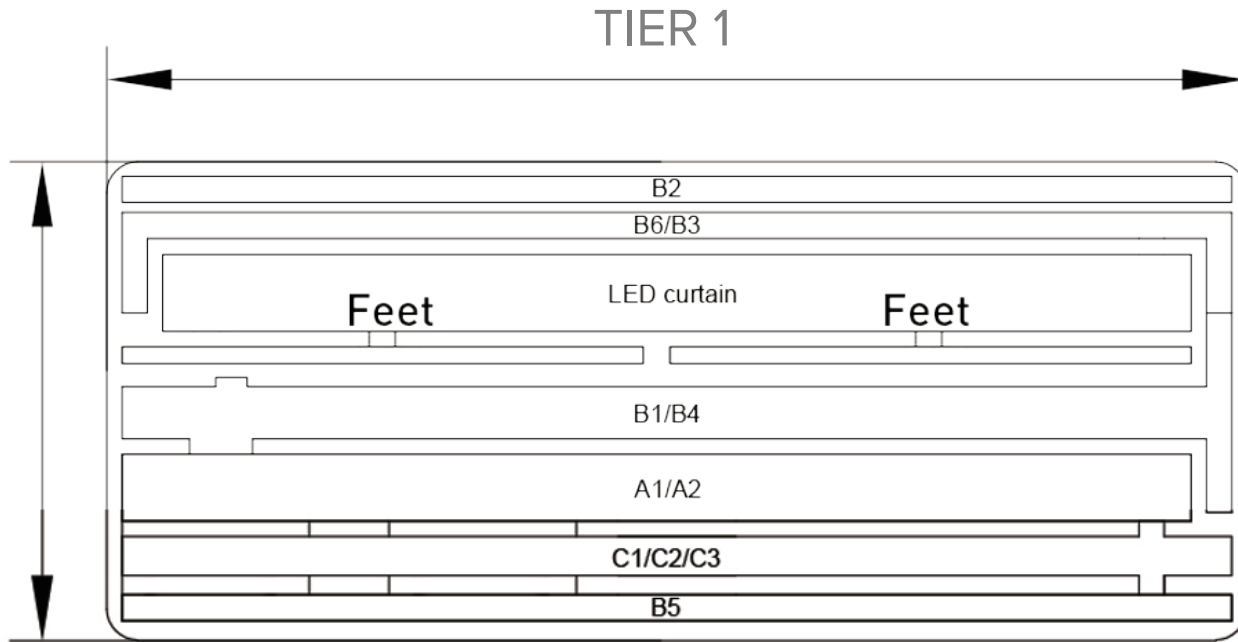

## TIER 2

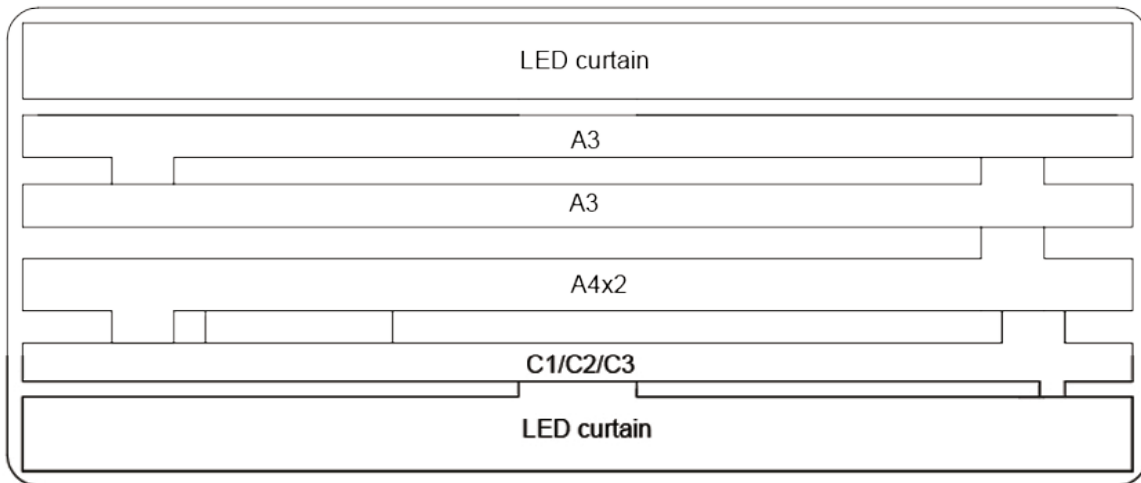



## LED & TRANSFORMER SPECS SB65-100X100

INFORMATION LISTED IS PER FRAME

LED LIGHTING	
Brand	OSRAM
CCT (COLOR TEMP)	6500K
AVG BEAM ANGLE	170
LM/W:	130
AVG LM/M <sup>2</sup>	6000-6500
VOLTAGE INPUT:	24V
LUMENS	
VOLTAGE (V)	24V
POWER (W)	120W
LM/W	130
TOTAL LM	6240
AVG LM	6240
CU	95-100%
EAV	2620lux

TRANSFORMER	
LED Driver UL Listed Class 2	
Output Wattage:	100W
Output Voltage	24V
Output Current	<b>6.67A</b>
Input Voltage	100-240 VAC
Input Frequency	50/60HZ
Input Current (max)	1.9A @ 100VAC
Operating Temp	-4°F to 122°F
Dimensions	19.69”L x 1.18”W x 0.67”H
Protections	Short Circuit / Over Voltage / Over Current / Overload Protection
Certifications	UL & CE Listed
Non-Dimmable	



LED Lights are attached to reflective fabric panel with Silicone Edge Graphic (SEG) finishing. Light panel installs into the inner channel on the backside of the lightbox frame. Panel is marked top/bottom for easy installation. Front side of panel is silver reflective material and backside is black.

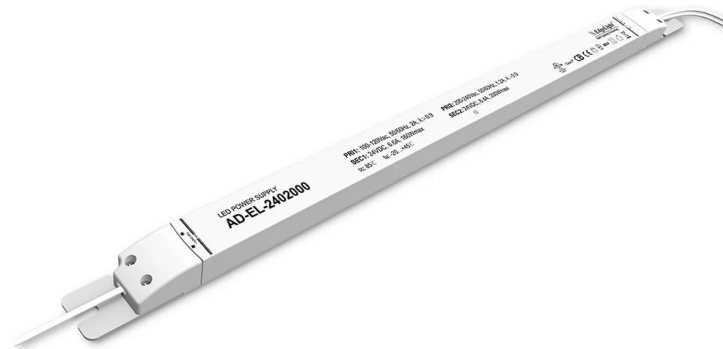

The transformer is mounted to the inside of the bottom frame profile. Transformer is pre-installed onto bottom profile from the factory and remains attached during frame storage. There are 2 exit locations on the right side of the frame for the power cord. One on the bottom profile and one on the bottom of the right vertical profile.

## LED & TRANSFORMER SPECS SB65-300X240

LED LIGHTING	
Brand	OSRAM
CCT (COLOR TEMP)	6500K
AVG BEAM ANGLE	170
LM/W:	130
AVG LM/M <sup>2</sup>	6000-6500
VOLTAGE INPUT:	24V
LUMENS	
VOLTAGE (V)	24V
POWER (W)	120W
LM/W	130
TOTAL LM	46800
AVG LM	6240
CU	95-100%
EAV	2620lux

TRANSFORMER	
Item #: AD-EL-2402000-B	
LED Driver UL Listed Class 2	
Output Wattage:	160W
Output Voltage	24V
Output Current	6.67A
Input Voltage	100-240 VAC
Input Frequency	50/60HZ
Input Current (max)	1.9A @ 100VAC
Operating Temp	-4°F to 122°F
Dimensions	19.69”L x 1.18”W x 0.67”H
Protections	Short Circuit / Over Voltage / Over Current / Overload Protection
Certifications	UL & CE Listed
Non-Dimmable	



LED Lights are attached to reflective fabric panel with Silicone Edge Graphic (SEG) finishing. Light panels install into the inner channel on the backside of the lightbox frame. Panel is marked top/bottom for easy installation. Front side of panel is silver reflective material and backside is black. The 300x240 frame includes 3 sets of LED light panels.

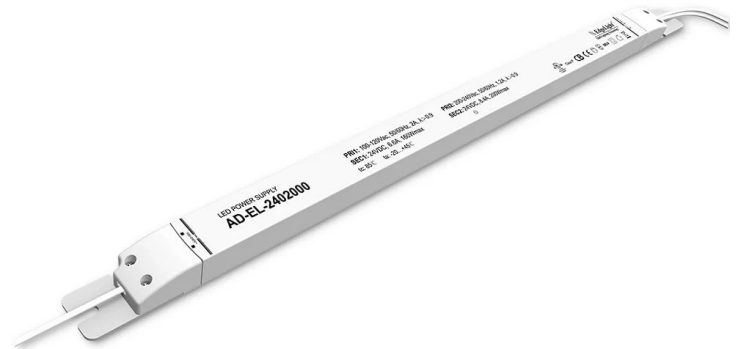

The transformer are mounted to the inside of the bottom frame profiles. Transformers are pre-installed onto bottom profiles from the factory and remain attached during frame storage. The 300x240 frame includes 3 transformers. There are 2 exit locations on the right side of the frame for the power cord. One on the bottom profile and one on the bottom of the right vertical profile.

## TEMPLATE GUIDE

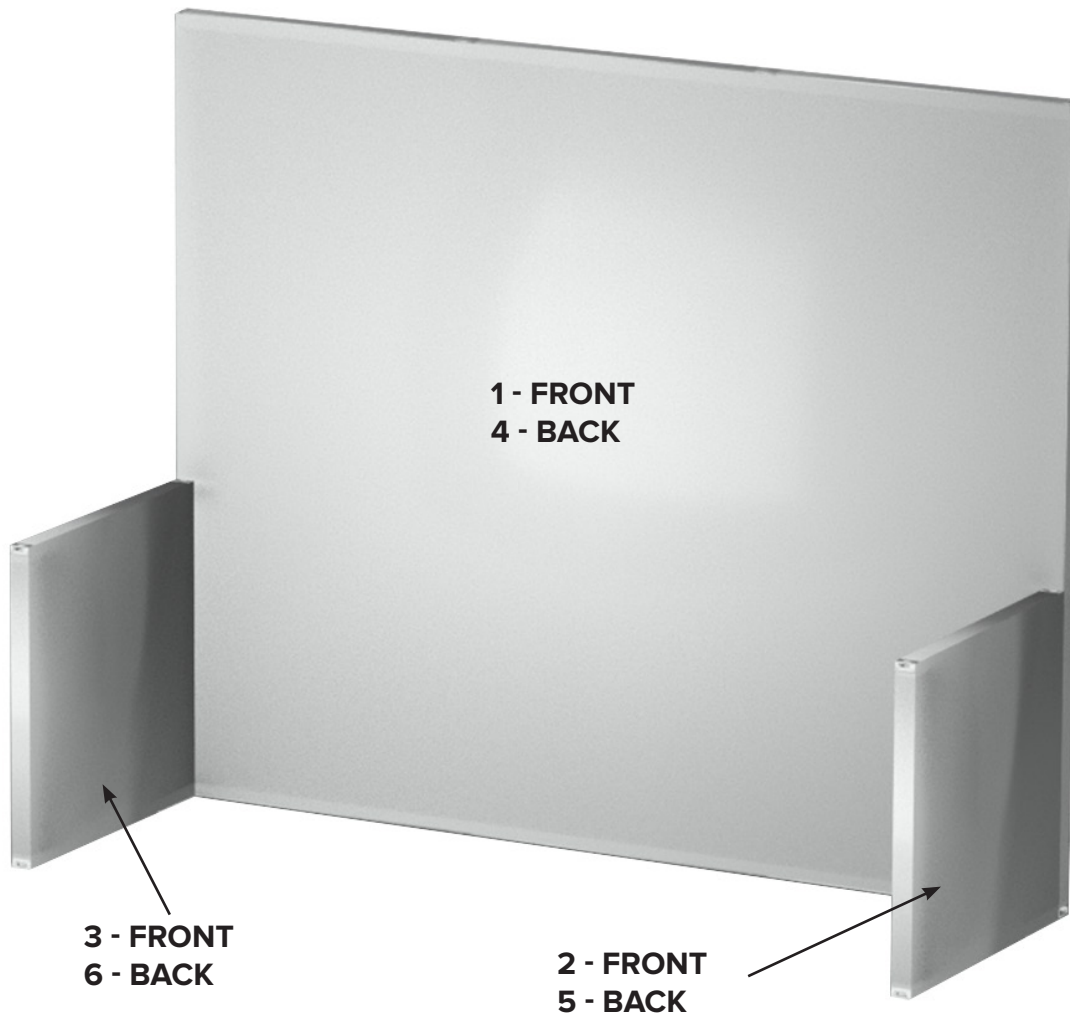

### SINGLE SIDED - BACKLIT

1. SB65-300X240 - BACKWALL
2. SB65-100X100 - RETURN
3. SB65-100X100 - RETURN

### DOUBLE SIDED - NON-BACKLIT

4. SB65-300X240 - BACKWALL
5. SB65-100X100 - RETURN
6. SB65-100X100 - RETURN

NUMBERS ON THE IMAGE ABOVE INDICATE THE TEMPLATE LOCATION # ON FRAME  
PLEASE USE TEMPLATE FILE NAME FOR EACH GRAPHIC FILE: "SB65-1010-B-1-BL"